

General Product Information

PRODUCT STANDARD / COMMENTS ON DEFINITIONS USED / CE MARKING / CONFORMITY TO COMPONENT STANDARDS / NATIONAL APPROVALS / PROTECTION

Product standard equipment standard

The product standard only contains minimum requirements. Attention is drawn to the fact that appliance specifications might contain requirements additional to or deviating from those specified in the relevant product standards.

Comments on definitions used

Please be aware that the specifications nominal value used in the German part of the Schurter catalogue and the data sheets, is synonymous with rated value. The difference between these two values is a pure matter of definition. In order to avoid any unnecessary complications we will continue to use the specifications nominal value.

CE marking acc. to EU-directives

CE marking is the only marking which indicates that a product conforms to the relevant EU-directive.



This means that the CE-mark is no quality or standard conformity mark but only an administration mark. SCHURTER products are covered by the low voltage directives 2006/95/EEC. Those are valid for equipment and appliances with rated voltage values between AC 50 V to AC 1000 V as well as DC 75 V to DC 1500 V. The CE marking of SCHURTER parts will be found on the label of the smallest packing unit. On request we will submit a CE conformity statement for each component. CE conformity statements and approvals can also be retrieved from the internet under <http://www.schurter.com>.

Conformity to component standards, national approvals

National testing institutions are testing according to national and international standards or other generally recognized rules of technology. Their certification/approval-marks confirm the observance of the safety requirements which electric appliances must fulfil.

Conformity to component standards, national approvals

National testing institutions are testing according to national and international standards or other generally recognized rules of technology. Their certification/approval-marks confirm the observance of the safety requirements which electric appliances must fulfil.

		Electrical Certification
	VDE	Verband Deutscher Elektrotechniker
	VDE	Verband Deutscher Elektrotechniker
	UMF	
	UL	Underwriters' Laboratories (USA, Canada)
	UL	Underwriters' Laboratories (USA, Canada)
	UL	Underwriters' Laboratories (USA)
	UL	Underwriters' Laboratories (USA, Canada)
	CSA	Canadian Standard Association, Component Acceptance Service
	CSA	Canadian Standard Association
	CCC	Chinese Compulsory Certification
	CQC	Chinese Quality Certification (voluntary)
	PSE	Japan Electrical Safety and Environment technology Laboratories
	KTL	Korea Testing Laboratory
	TÜV	Technischer Überwachungsverein
	NF	Norme française
	SEV	Schweizerischer Elektrotechnischer Verein
	SEMKO	Svenska Elektriska Materielkontrollanstalten
	FIMKO	Finnish Electrical Inspectorate
	KEMA	Keuring van Elektrotechnische Materialien
	IMQ	Instituto italiano del marchio di qualità

National approvals

In addition to the combined UL/CSA approvals, most of the SCHURTER components are also approved by one of the European certification bodies like VDE (Germany), Electrosuisse (Switzerland) or SEMKO (Sweden). The safety testing of all these European certification bodies are based on the common European safety standards. With the harmonisation effort in Europe, the different national European certification bodies have lost their importance and SCHURTER

General Product Information

has decided to maintain only one European approval (e.g. VDE, SEV or SEMKO) in future. The others will not be renewed once they have expired.

Because UL and CSA are not members of the CENELEC, the standards of UL and CSA are not harmonised yet with the European standards. However, UL and CSA are trying to harmonize their standards with each other. Where possible, SCHURTER will apply for the combined cULus or cURus approval.

Further to development in Asia, SCHURTER has obtained national approvals from China, Japan and Korea.

Information about approvals

SCHURTER products are certified according to EN / IEC standards and carry country specific approvals in Europe.

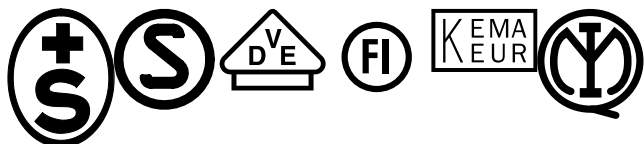

During the last few years European countries made much effort to reduce their approval marks to one generally accepted mark. The ENEC approval mark replaces (wherever possible) the previous approval mark. The ENEC mark is offered by all national certification bodies that signed for the European certification agreement (CCA)*.

SCHURTER decided to reduce the variety of European approval marks. For new approbations of SCHURTER parts only the ENEC will be mentioned in the future:



Approvals for the US and Canada are according to the UL and CSA standards:



As UL and CSA are not a member of CENELEC these two are not according to the European approval marks. Wherever possible SCHURTER want to acquire the combined cULus approval mark:



Since Aug. 1st. 2003 the Chinese approval mark is required for a lot of products to import to China. SCHURTER strives to get the approvals for the concerned products.

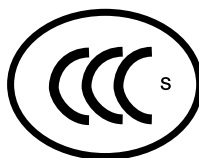

SCHURTER will check if a voluntary CQC registration can be done when a product does not apply with a Chinese standard.



Further information:
<http://www.enec.com>

Approval Industry Links

* members of ENEC agreement:

Reference	Key	Country
01	IMQ	Italy
02	KEMA	Netherlands
03	VDE	Germany
04	SEV	Switzerland
05	SEMKO	Sweden

IP DEGREES OF PROTECTION PROVIDED BY ENCLOSURES (IP CODE)

Standards IEC 60529; EN 60529 and DIN 40050

Scope

These standards apply to the classification of degrees of protection provided by enclosures for electrical equipment with a rated voltage not exceeding 72.5 kV.

Object

The object of these standards is to give:

a) Definitions for degrees of protection provided by enclosures of electrical equipment as regards:

1. Protection of persons against access to hazardous parts inside the enclosure
2. Protection of the equipment inside the enclosure against ingress of solid foreign objects
3. Protection of the equipment inside the enclosure against harmful effects due to the ingress of water.

b) Designations for these degrees of protection.

c) Requirements for each designation.

d) Tests to be performed to verify that the enclosure meets the requirements of these standards.

Designations

The degree of protection provided by an enclosure is indicated by the

General Product Information

IP code.

Elements of the IP code and their meanings

A brief description of the IP code elements is given in the following table.

IP xy	Meaning for the protection of equipment	Meaning for the protection of persons
	Against ingress of solid foreign objectif	Against access to hazardous parts with
x = 0	(non protected)	(non protected)
x = 1	50 mm diameter	back of hand
x = 2	12.5 mm diameter	finger
x = 3	2.5 mm diameter	tool
x = 4	1.0 mm diameter	wire
x = 5	dust protected	wire
x = 6	dust tight	wire
	Against ingress of water with harmful effects	
y = 0	(non protected)	
y = 1	vertically dripping	
y = 2	dripping (15° tilted)	
y = 3	spraying	
y = 4	splashing	
y = 5	jetting	
y = 6	powerful jetting	
y = 7	temporary immersion	
y = 8	continuous immersion	
y = 9K	high pressure, i.e. steam jet cleaning	

Information about IP Protection

Information about IP protection levels may vary depending on mounting or application for the various components. Following explanations are supplemented for this purpose.

There are cases where more than one IP value is mentioned for a product. Then this values are separated by a slash or by the term "or". This information is given for families or on series level to indicate that there are different variants with respective IP protection degrees. In some cases there will be further information about the respective conditions to ensure the tightness said. e.g.. 40 / 54 with sealing kit

IP Protection from Front Side

This mounting perspective means the protection against the ingress of foreign substances from the outside into the interior of the appliance. Accordingly, it comes to the sealing of the offered component against the housing and also the sealing of moveable elements which are accessible from the outside.

IP Protection from Rear Side

This is basically the opposite to the mounting of the front side. The listed IP value means the protection level from the rear side of the selected part, so it is focusing on the inside of the appliance. This information can be important when there is an intention of potting the components inside the housing. This specification is also noted

whether a component is suitable for this process.

Detailed IP Information According to Product Feature

If the IP rating of a component is particularly high, then the respective sealing areas have to be addressed in detail in order to explain the requirements for a successful sealing. These detailed mounting instructions are correspondingly provided for the respective products. The sealing from the component towards the housing is the primary goal. Accordingly here the seal is described against the flange and the attachment area. In addition, more information coming from the moving parts, or even the insertion region. Mounting standard versionA) front viewB) detail front mounting typeC) detail rear mounting type

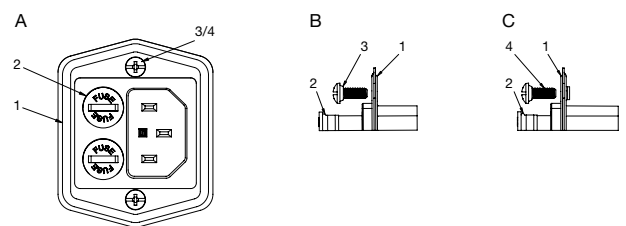

A) Front view B) Details of front mounting C) Details of rear mounting
1) sealing of flange 2) sealing of fuseholder 3) sealing of screw hole (front mounting type: sealing ring on screw head) 4) sealing of screw hole (rear mounting type: sealing on screw thread)

Information on IP Protection in Unmated and Inserted State

In connector systems, the operating condition is taken into account if a unit has to be tight under current supply, this corresponds to the so-called inserted state. 6100-3 with sealing kit IP 54



Otherwise, it may happen that a device must be sealed for transport or cleaning phase in which the power supply cable is not connected to the device. This mentioned case is referred to IP protection when unmated..

General Product Information



Available products to enhance the IP protection level are listed as accessory products. It is important that the necessary components are used according to the specifications as for example using a connector with the proposed cord retainer.

6100-3 incl. sealing kit for IP 541) Appliance inlet 6100-3 with factory-mounted inlet gasket2) Flat gasket3) Chassis4) Pillar5) Gasket ring6) Crinkle washer7) Nut8) Retaining clip

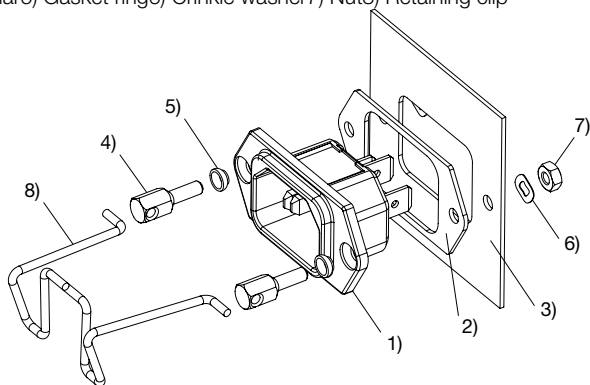

1) Appliance inlet 6100-3 with factory-mounted inlet gasket 2) Flat gasket 3) Chassis 4) Pillar 5) Gasket ring 6) Crinkle washer 7) Nut 8) Retaining clip

Product Overview with IP Protection Level Indication

The IP values are depending on the product range optional or recommended selection criteria in the catalog refinement search. The complementary accessories and matching components are referenced in the respective product data sheets.

PROTECTION AGAINST ELECTRIC SHOCK

1. Protection against direct and indirect contact general terms

The protection against electric shock on electric equipment as well as their components are divided into the following parts:

- Protection against direct contact with live parts concerns all measures for the protection of human beings and animals against hazards which result from direct contact with live parts of electric equipment and their components.
- Protection against indirect contact is the protection of human beings and animals against hazards which result from contact of live parts ¹⁾ of electric equipment as well as components thereof, which have become live due to an insulation failure.



¹⁾ Accessible, conductive part, which is not conductive normally but which may be conductive due to a failure.

2. Protection against direct contact with live parts e.g. of a fuseholder

The data sheets of the relevant components inform about the taken measures.

3. Protection against indirect contact

Measures for the protection against indirect contact on electrical equipment are defined according to IEC 61140 by the 4 protection classes 0, I, II, III. Each protection class includes two protection measures. Even if one of these measures should fail, no electric shocks will occur.

Protection class	Main protective measures
0	<ol style="list-style-type: none"> 1. Basic insulation between live parts and accessible conductive parts. 2. Earth-free location, non-conducting environment.
I	<ol style="list-style-type: none"> 1. Basic insulation between live parts and accessible conductive parts. 2. Means are provided for the connection of accessible conductive parts of the equipment to the protective (earthing) conductor in the fixed wiring of the installation in such a way that accessible conductive parts cannot become live in the event of a failure of the basic insulation. 
II	<ol style="list-style-type: none"> 1. Basic insulation between live parts and accessible conductive parts. 2. Additional insulation. Basic and supplementary insulation are summarised under the term "double insulation". Under certain circumstances also a "reinforced insulation" (single insulation system) may guarantee an equivalent protection against electric shock as a "double-insulation" does. No terminal for a protective conductor is allowable. A possibly existing protective conductor must not be connected and has to be insulated like any live part. 
III	<ol style="list-style-type: none"> 1. Functional insulation. 2. Supply at safety extra-low voltage SELV (the circuit is isolated from the mains supply by such means as a safety isolating transformer). The protection against electric shock is in this case completely based on the supplying by SELV-circuits ($U \leq 42$ V). Higher voltages are not generated in the equipment. No terminal for a protective conductor is allowable. 

General Product Information

FUSEHOLDERS

Protection against contact

Protection against electric shock (against direct contact with live parts), for fuseholders
 The assessment of the protection against electric shock assumes that the fuseholder is properly assembled, installed and operated as in normal use, e.g. on the front panel of the equipment.

IEC 60127-6 and EN 60127-6 divides into three categories:

Category	Features
PC1	Fuseholders without integral protection against electric shock. They are only suitable for applications where corresponding additional means are provided to protect against electric shock.
PC2	Fuseholders with integral protection against electric shock live part is not accessible: - when the fuseholder is closed - after the fuse carrier (incl. fuse-link) has been removed - either during insertion or removal of the fuse carrier (incl. fuse-link) Compliance is checked by using the standard test finger specified in IEC 60529.
PC3	Fuseholder with enhanced integral protection against electric shock The requirements for this category are the same as those for category PC2, with the exception that the testing is carried out with a rigid test wire of 1 mm diameter according to IEC 60529, table VI, instead of the standard test finger.

a) Closed fuseholder

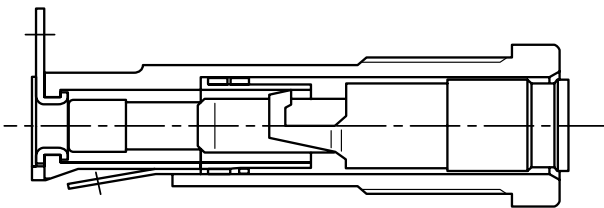

b) When the fuse carrier is removed, no live parts can be touched.

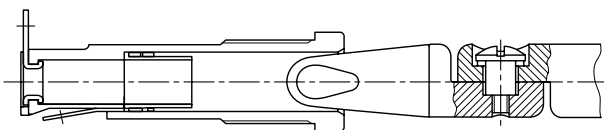

c) During insertion or removal of a fuse-link no live parts can be touched neither through the fuse-link nor the fuse carrier.

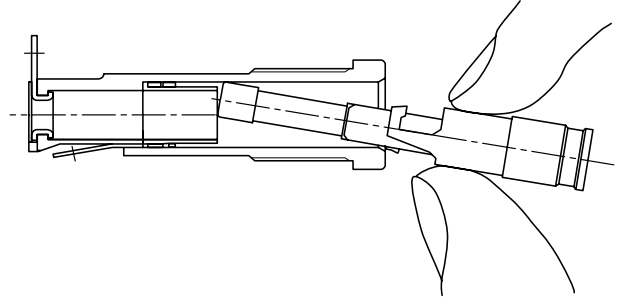

Remarks on PC 3



Thermal requirements of the fuseholder

Influencing factors

The design engineer of electrical equipment is responsible for its safety and functioning to humans, animals and real values. Above all, it is his task to make sure that the state of the art as well as the valid national and international standards and regulations be observed.

In view of the safety of electrical equipment the selection of the most suitable fuseholder is of great importance. Among other parameters, one has to make sure that the maximum admissible power acceptances and temperatures defined by the manufacturer are followed. Differing definitions and requirements in the most important standards for fuse-links and fuseholders are time and again origin for the incorrect selection of fuseholders.

To equate the rated current of a fuse-link with the rated current of the fuseholder, may, especially at higher currents, cause high, not admissible temperatures, when the influence of the power dissipation in the contacts of the fuseholder was not taken into consideration.

For a correct selection the following influence factors depending on the application and mounting method, have to be taken into consideration.

It is recommended testing the fuseholder with the chosen fuse-link in the worst case operating condition.

1. Rated power dissipation of the suitable fuse-link.
2. Admissible power acceptance, operating current and temperatures of the suitable fuseholder.
3. Differing ambient air temperature outside and inside of the equipment.
4. Electrical load alternation

General Product Information

5. Long time (> 500 h) operation with load > 0.7 I_n.
6. Heat dissipation/cooling and ventilation. Heat influence of adjacent components.
7. Length and cross section of the connecting wire.

Rated current of a fuseholder

The value of current assigned by the manufacturer of the fuseholder and to which the rated power acceptance is referred.

Rated power dissipation of the fuse-link

(power dissipation at rated current)

Rated power acceptance and admissible temperatures of a fuseholder.

The rated power acceptance of a fuseholder is determined by a standardised testing procedure according to IEC 60127-6. It is intended to be the power dissipation caused by the inserted dummy fuse-link at the rated current of the fuseholder and at an ambient air temperature of T_{A1} = T_{A2} = 23 °C (over a long period). During this test the following temperatures must not be exceeded on the surface of the fuseholder:

Fuseholder surface area	Maximum allowable temperature measuring points (see figure 1)	°C
1. Accessible parts ¹⁾	T _{S1}	85
2. Inaccessible parts ¹⁾ Insulating parts	T _{S2}	²⁾

Notes:

- 1) When the fuse-holder is properly assembled, installed and operated as in normal use, e.g. on the front panel of equipment.
- 2) The maximum allowable temperature of the used insulating materials corresponds to the Relative Temperature Index (RTI) according to IEC 60216-1 or UL 746 B.

Illustration of temperatures experienced in practice

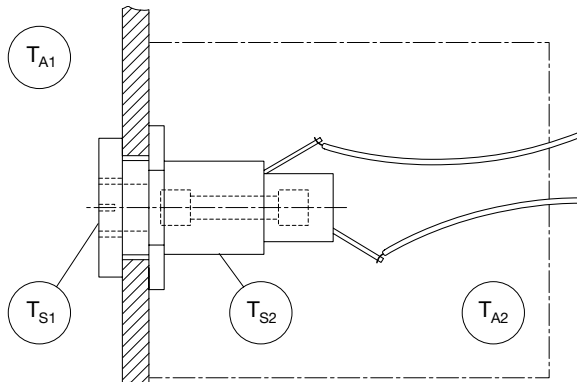

- T_{A1} = ambient air temperature, surrounding the equipment
- T_{A2} = ambient air temperature in the equipment
- T_{S1} = temperature of accessible parts on fuseholder surface
- T_{S2} = temperature of inaccessible parts on fuseholder surface

Correlation between operating current I, ambient air temperature T_{A1} and the power acceptance P_h of the fuseholder.

This correlation is demonstrated by derating curves.

Example of a derating curve

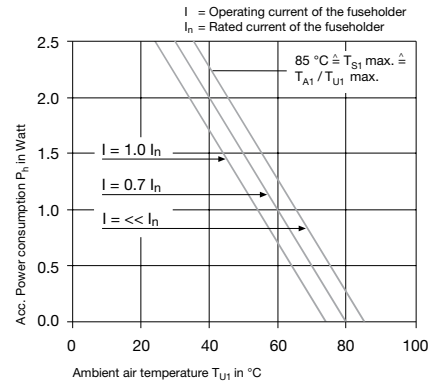

I = operating current of the fuseholder
I_n = rated current of the fuseholder

The derating curves demonstrate the admissible power acceptance of a fuseholder depending on the ambient air temperature T_{A1} for the following fuseholder operating currents: I << I_n, I = 0.7 · I_n and I = 1.0 · I_n. This power acceptance corresponds to the max. admissible power dissipation of a fuse-link.

The corresponding values for other operating currents can be interpolated between the existing curves or calculated as follows:

$$P_h = P_o - P_c = P_o - (R_c \cdot I^2)$$

P_h = admissible power acceptance in watt of the fuseholder, depending on T_{A1}.

P_o = admissible power acceptance in watt of a fuseholder at I << I_n, depending on T_{A1}. The values can be taken from the derating curve I << I_n of the corresponding fuseholder.

P_c = power dissipation in watt in the fuseholder contacts at the operating current in ampere.

I = operating current in ampere of the fuseholder.

R_c = contact resistance in ohm between the fuseholder terminals according to SCHURTER's catalogue.

Selection

Selection of a suitable fuseholder with respect to the power acceptance at the corresponding ambient air temperature.

Summary

The adherence to the limits, indicated by SCHURTER, in particular the power acceptance limits at the corresponding ambient air temperatures and mounting conditions of the fuseholder, is important for the safety of the product. It is therefore necessary to observe the following two steps:

Step 1

Selection of the fuseholder based on the power acceptance P_h at operating current I and maximum ambient air temperature T_{A1}.

$$P_f \leq P_h = P_o - P_c = P_o - (R_c \cdot I^2)$$

P_f = rated power dissipation in watt of the fuse-link, calculated from (I_n · U), whereas:

I_n = rated current in ampere of the fuse-link

ΔU = voltage drop in volt at I_n; values according to SCHURTER's catalog.

P_h, P_o, P_c, R_c = see pos. 2.5

Step 2

The reduction of the power acceptance of the fuseholder (from step 1) based on the different conditions at the mounting place etc. have to be determined by the design engineer responsible.

Examples:

- ambient air temperature is considerably higher inside of an equip-

General Product Information

- ment than outside ($T_{A2} > T_{A1}$)
- cross-section of the conductor, unfavourable heat dissipation
- heat influence of adjacent components

Therefore, temperature measurements on the appliance under normal and faulty conditions are absolutely necessary.

Example

What's given?

- Fuse-link FSF 0034.1523, rated current $I_n = 5$ A. Voltage drop ΔU at $I_n = 80$ mV, typ.
- SCHURTER - Electronic Components for safe power and easy to use interfaces



Rated power dissipation $P_f = (I_n \cdot \Delta) = (5 \text{ A} \cdot 0.08 \text{ V}) = 0.4 \text{ W}$.

- Fuseholder FEF 0031.1081, rated current $I_n = 10$ A
Rated power acceptance at $T_{A1} 23$ °C = 3,2 W.
- Ambient air temperature = 50 °C.
Admissible power acceptance P_h at an ambient air temperature T_{A1} 50 °C according to the derating curve:

$$P_h \text{ at } I \ll I_n = 2.5 \text{ W}$$

$$I = 0.7 \cdot I_n = 7 \text{ A} = 2.2 \text{ W}$$

$$I = 1.0 \cdot I_n = 10 \text{ A} = 2 \text{ W}$$

- Contact resistance $R_c = 5 \text{ m}\Omega$

What is the admissible power acceptance P_h of the fuseholder?

Solutions

The result of the interpolation for the rated current $I = 5$ A is a P_h of approx. 2,4 W.
The result of the calculation is
 $P_h = P_o \cdot (R_c \cdot I^2) = 2.5 \cdot (0.005 \cdot 5^2) = 2.37 \text{ W} \approx 2.4 \text{ W}$.

Derating curves of the fuseholder, type FEF, rated current $I_n = 10$ A

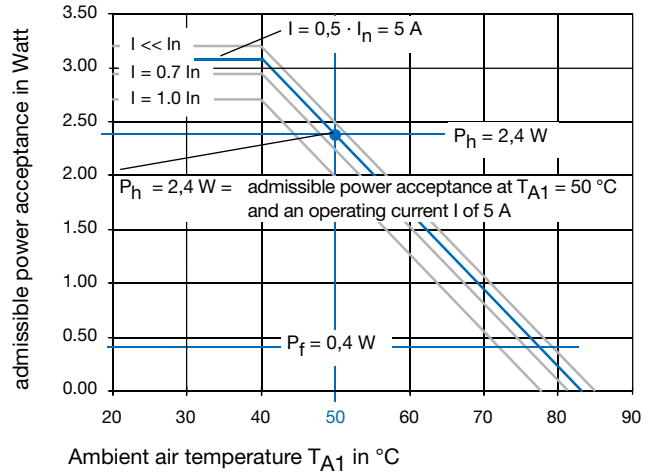

Verification of the thermal requirements

Step 1

The following condition must be fulfilled:

$P_f \leq P_h$ this means: the rated power dissipation P_f of the fuse-link must be less/equal than the admissible power acceptance P_h of the fuseholder.

$$P_f = 0.4 \text{ W}; P_h = 2.4 \text{ W at } T_{A1} = 50 \text{ °C}$$

Step 2

To consider the different conditions at the mounting place

Conclusion (without consideration of step 2)

- The value P_f is less than P_h . The condition according to formula is fulfilled. It has been chosen a suitable fuseholder.
- If the value P_f were greater than P_h the condition wouldn't be fulfilled. In that case, do select another fuseholder with a higher power acceptance or change the thermal conditions at the fuseholder mounting place.

Standards for fuseholders

IEC 60127-6	Fuseholders for miniature fuse-links
NF C93-436	Fuseholders for professional purposes
UL4248-1	Fuseholders
CSA C22.2 NO. 4248.1-07	Fuseholder assemblies

IEC: International Electrotechnical Commission
UL: Underwriters Laboratories Inc. USA
CSA: Canadian Standards Association
NF: French Standard

Explanation to the main fuseholder standards

As mentioned in section 2, the most relevant standards define rated current and rated power acceptance differently. This lead in the past often to confusion or even to a wrong fuseholder design-in.

For example the standard UL 512 does not define a maximum power acceptance value, but sets a certain value of temperature rise for the fuseholder. For this reason the marked amperage values on the fuseholder, defined by UL and CSA, are not suggested to be used except in special cases.

In order to eliminate such confusion, SCHURTER new decided to define the rated current and rated power acceptance values according to IEC 60127-6 and EN 60127-6.

General Product Information

The most important definitions are to be found in section 2.

Conclusion

- The high UL and CSA current ratings are replaced by more realistic rated currents defined by SCHURTER.
- Focused on the new fuseholder standard IEC 60127-6 and EN 60127-6, the power acceptance of several fuseholders had to be reduced.
- The design-in procedure and in particular to choose the correct fuseholder in terms of thermal requirements (refer to section 2-4) is now made much easier.

Your advantages:

- More security for your equipment
- Faster and much easier selection of the correct fuseholder

SOLDERING PROFILE

SCHURTER components for printed circuit boards are suitable for common solder processes. THT components can be wave soldered with a peak temperature of 230 to 260°C. SMD components are suitable for reflow soldering with a peak temperature of 260°C. Please note the soldering specification on the product data sheet.

Recommended Wave Soldering Profile

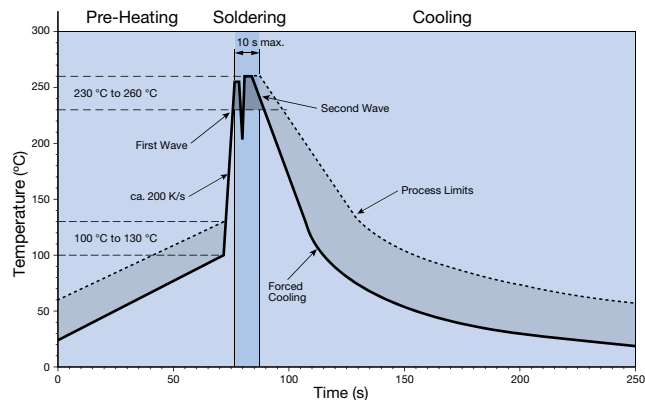

The solder temperature 230°C - 260°C depends on the solder classification of the components.

Recommended Reflow Soldering Profile

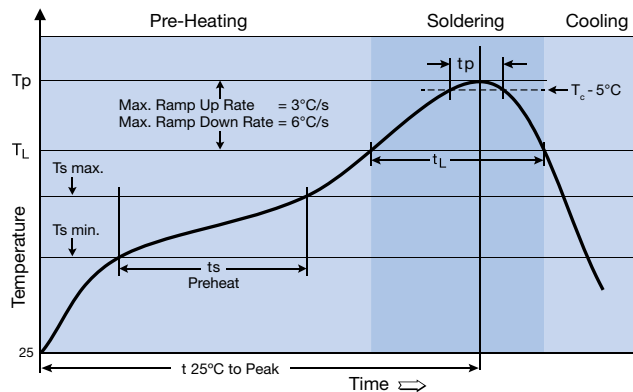

Soldering Profile

Reflow feature	Pb-Free assembly
Preheat	
Temperature Min ($T_{s \text{ min}}$)	150°C
Temperature Max ($T_{s \text{ max}}$)	200°C
Time (t_p) for ($T_{s \text{ min}}$ to $T_{s \text{ max}}$)	60 - 120 secs
Ramp-up rate (T_L to T_p)	3°C / secs max.
Liquidous temperature (T_L)	217°C
Time (t_L) maintained above (T_L)	60 - 150 secs
Time (t_p) below 5°C of max. peak temperature	30 secs max.
Ramp-down rate (T_p to T_L)	6°C / secs max.
Time 25°C to peak temperature	8 mins max.
Peak temperature maximum	260°C
* The peak temperature depends also on the component volume (see JEDEC J-STD-020D)	