

IEC Appliance Inlet C8, insert Mounting, Solder, PCB or Quick-connect Terminal



See below:

[Approvals and Compliances](#)

Description

- Drop-in type
- Appliance Inlet , Pin temperature 70 °C , Protection class II
- Solder / Quick Connect / PCB Terminal

Characteristics

- Contact pins are turned from solid material

References

We recommend for new applications the type [0720-FP](#)

Weblinks

[pdf data sheet](#), [html datasheet](#), [General Product Information](#), [Approvals](#), [Distributor-Stock-Check](#), [Accessories](#), [Detailed request for product](#)

Technical Data

Ratings IEC	2.5 A / 250 VAC; 50Hz	Appliance inlet/-outlet	C8 acc. to IEC/EN 60320-1 UL 60320-1, CSA C22.2 no. 60320-1 (for cold conditions) pin-temperature 70 °C, 2.5 A, Protection Class II
Ratings UL/CSA	7 A / 125VAC; 60Hz		
Dielectric Strength	> 4 kVAC between L-N > 2 kVAC between L/N-PE (1 min/50Hz)		
Allowable Operation Temperature	-25 °C to 70 °C		
IP-Protection	front side IP20 acc. to IEC 60529		
Protection against electric shock	Suitable for appliances with protection class II acc. to IEC 61140		
Terminal	Solder / Quick Connect / PCB Terminal in line with PIN-axis		
Material: Housing	PA6, black / grey / white, UL 94V-0		

Approvals and Compliances

Detailed information on product approvals, code requirements, usage instructions and detailed test conditions can be looked up in [Details about Approvals](#)

SCHURTER products are designed for use in industrial environments. They have approvals from independent testing bodies according to national and international standards. Products with specific characteristics and requirements such as required in the automotive sector according to IATF 16949, medical technology according to ISO 13485 or in the aerospace industry can be offered exclusively with customer-specific, individual agreements by SCHURTER.



Approvals

The approval mark is used by the testing authorities to certify compliance with the safety requirements placed on electronic products.
 Approval Reference Type: 2572

Approval Logo	Certificates	Certification Body	Description
	VDE Approvals	VDE	VDE Certificate Number: 40034368
	UL Approvals	UL	UR File Number: E96454
	CSA Approvals	CSA	CSA Certification Record: 27324
	CCC Approvals	CCC	CCC Certificate Number:

Product standards

Product standards that are referenced

Organization	Design	Standard	Description
	Designed according to	IEC/EN 60320-1	Appliance couplers for household and similar general purposes
	Designed according to	UL 60320-1	Standard for Attachment Plugs and Receptacles
	Designed according to	CSA C22.2 no. 60320-1	General Use Receptacles, Attachment Plugs, and Similar Wiring Devices





Application standards

Application standards where the product can be used

Organization	Design	Standard	Description
	Suitable for applications acc.	IEC/UL 62368-1	Audio/video, information and communication technology equipment - Part 1: Safety requirements

Compliances

The product complies with following Guide Lines

Identification	Details	Initiator	Description
	CE declaration of conformity	SCHURTER AG	The CE marking declares that the product complies with the applicable requirements laid down in the harmonisation of Community legislation on its affixing in accordance with EU Regulation 765/2008.
	UKCA declaration of conformity	SCHURTER AG	The UKCA marking declares that the product complies with the applicable requirements laid down in the British Amendment of Regulation (EC) 765/2008.
	RoHS	SCHURTER AG	Directive RoHS 2011/65/EU, Amendment (EU) 2015/863
	China RoHS	SCHURTER AG	The law SJ / T 11363-2006 (China RoHS) has been in force since 1 March 2007. It is similar to the EU directive RoHS.
	REACH	SCHURTER AG	On 1 June 2007, Regulation (EC) No 1907/2006 on the Registration, Evaluation, Authorization and Restriction of Chemicals 1 (abbreviated as "REACH") entered into force.

Dimensions [mm]

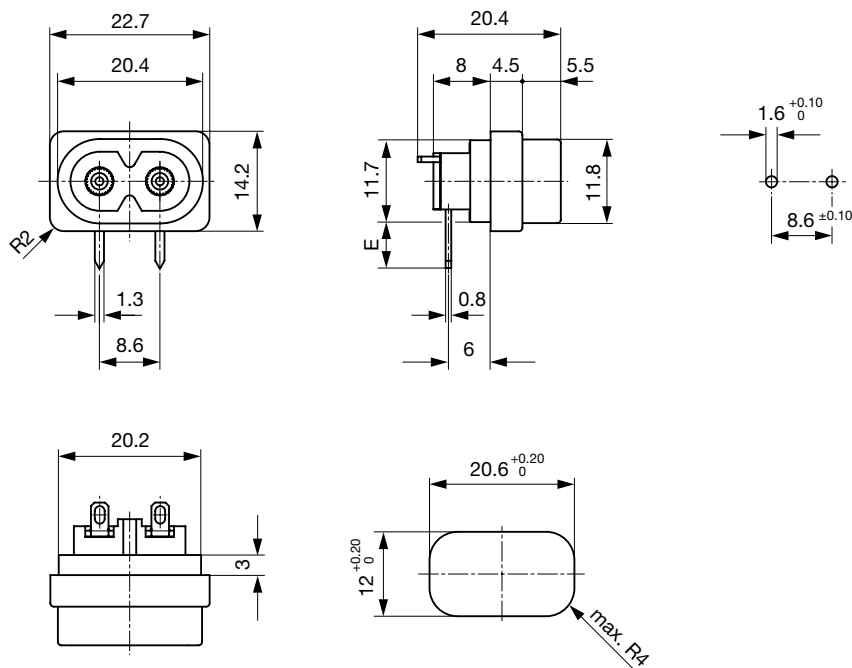

E = PCB terminal standard (additional solder): 6.8 mm

E = PCB terminal short (additional solder): 0.6 mm

E = PCB terminal long (additional solder): 15.8 mm

E = PCB terminal standard: 6.5 mm

E = PCB terminal short: 5.0 mm

E = PCB terminal long: 7.6 mm

Quick connect or solder terminal in orientation A (horizontal) or B (vertical)

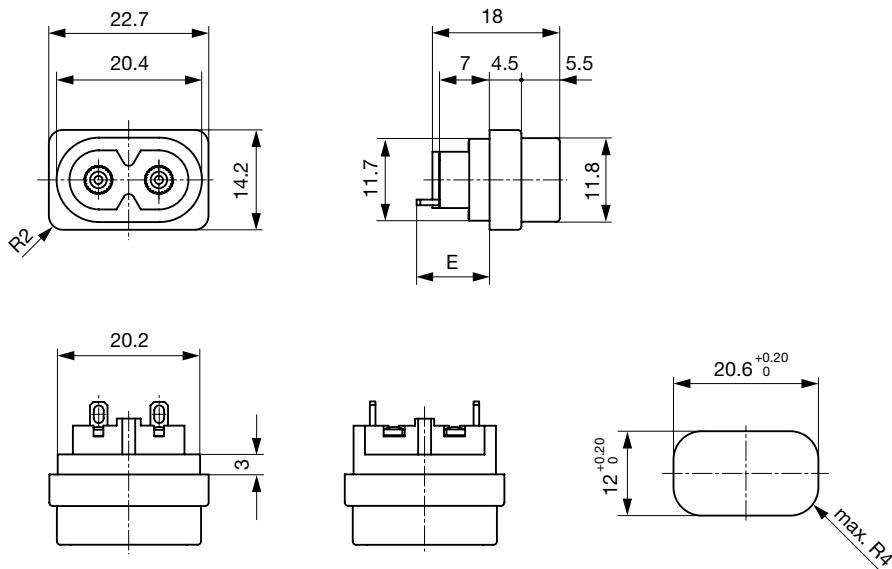

- E = Solder terminal short: 10.5 mm
- E = Solder terminal long: 14.2 mm
- E = Quick-connect terminal 2.8x0.8 mm: 16.5 mm
- E = Quick-connect terminal 4.8x0.8 mm: 15.0 mm (only orientation B)

Config. Code





2572 - H - A B C 0 - D - E G F

The characters are placeholders for the correspondingly keys of selections from the key tables.

2572 - H - A B C 0 - D - E G F = Type

Type	Configuration key
protection class II	X

2572 - H - A B C 0 - D - E G F = Terminals

Terminal L	Configuration key
short solder terminal (L = 4.8 mm) 	2
long solder terminal (L = 8.5 mm) 	3
PCB-terminal standard (additional solder terminal) 	4
PCB-terminal short (additional solder terminal) 	5
PCB-terminal long (additional solder terminal) 	6

Terminal L

Blade terminal (2.8 x 0.8 mm)



7

Blade terminal (4.8 x 0.8 mm)



8

PCB-terminal (standard)



A

PCB-terminal (short)



B

PCB-terminal (long)



C

2572 - H - A B C 0 - D - E G F = Terminals

Terminal N

short solder terminal (L = 4.8 mm)

2

long solder terminal (L = 8.5 mm)

3

PCB-terminal standard (additional solder terminal)

4

Symbols similar as in table A

Terminal N	Configuration key
PCB-terminal short (additional solder terminal)	5
PCB-terminal long (additional solder terminal)	6
Blade terminal (2.8 x 0.8 mm)	7
Blade terminal (4.8 x 0.8 mm)	8
PCB-terminal (standard)	A
PCB-terminal (short)	B
PCB-terminal (long)	C

Symbols similar as in table A

2572 - H - A B C 0 - D - E G F = Terminals

Terminal Ground	Configuration key
without terminal	0

Symbols similar as in table A

2572 - H - A B C 0 - D - E G F = Color

Color	Configuration key
Black	A

Color	Configuration key
Grey	B
White	D

2572 - H - A B C 0 - D - E G F = Style

Style	Configuration key
insert type	5

2572 - H - A B C 0 - D - E G F = Dimension S

Dimension "S"	Configuration key
00	

The dimension "S" is displayed in (1/10 mm). This information is also valid for the order code

2572 - H - A B C 0 - D - E G F = Orientation of Terminals

Orientation of Terminals	Configuration key
horizontal	A
vertical	B

All Variants

Terminals L / N	Orientation of Terminals	Color	Style	Config. Code	Order Number
short solder terminal (L = 4.8 mm)	horizontal	Black	insert type	2572-X-2200-A-500A	6160.0008
PCB-terminal short (additional solder terminal)	horizontal	Black	insert type	2572-X-5500-A-500A	6160.0009
PCB-terminal long (additional solder terminal)	horizontal	Black	insert type	2572-X-6600-A-500A	6160.0010
Blade terminal (4.8 x 0.8 mm)	vertical	Black	insert type	2572-X-8800-A-500B	6160.0026
PCB-terminal (long)	horizontal	Black	insert type	2572-X-CC00-A-500A	6160.0030
PCB-terminal (short)	horizontal	Black	insert type	2572-X-BB00-A-500A	6160.0044

The listed variants should be available from stock. Other versions on request www.schurter.com/contact

Most Popular.

Availability for all products can be searched real-time: <https://www.schurter.com/en/info-center/support-tools/stock-check-distributors>

Packaging unit

100 Pcs

Accessories

Description



Wire_Harness
 Wire harness for SCHURTER products

Mating Outlets/Connectors

Category / Description

[Power Cord Overview complete](#)



Cord Sets 2.5 A, IEC Connector, Black, 2.0 m, H03VH2-F 2x0,75mm2, Connector IEC C7, H05VH2-F 2x0.75 mm2 2m BLK, black	6013.0474
Cord Sets 2.5 A, IEC Connector, Black, 4.0 m, H03VH2-F 2x0,75mm2, Connector IEC C7, H05VH2-F2G0.75, black	6013.0478

[Power Supply Cord Overview complete](#)



Cord Sets 2.5 A, North America, Black, 2.0 m, SVT 2x18AWG, Connector IEC C7, NISPT-2, black	6010.5274
Cord Sets 2.5 A, North America, Black, 4.0 m, SVT 2x18AWG, Connector IEC C7, NISPT-2, black	6010.5278