

IEC Appliance Inlet C8 polarized with Line Switch 1-pole



CMF2
 IEC connector C8 polarized with line switch 1-pole
 PCB

C8 polarized



70° C

Description

- Panel mount :
 Screw-on mounting on PCB , from top / bottom
- 2 Functions :
 Appliance Inlet Protection class II , Line Switch 1-pole
- For PCB mounting

Characteristics

- Easy mounting with center bolt and snapper or screwed on PCB or housing
- Electrical connection done on the PCB
- Standard CMF with switch on the right side
- With or without rear-side insulation cover
- Suitable for use in equipment according to IEC/UL 62368-1

Other versions on request

- Line switch with other rocker marking

References

Alternative: unpolarized version or protection class I [CMF1](#); [CMF3](#)

Weblinks

[pdf data sheet](#), [html datasheet](#), [General Product Information](#), [Approvals](#), [Distributor-Stock-Check](#), [Accessories](#), [Detailed request for product](#)

Technical Data

| | |
|-----------------------------------|--------------------------------------------------------------------|
| Ratings IEC | 2.5 A / 250 VAC; 50Hz |
| Ratings UL/CSA | 2.5 A / 250VAC; 60Hz 7A / 125 VAC; 60Hz |
| Dielectric Strength | > 2.3kVAC between L-N > 2.8kVAC between L/N-PE (1 min/50Hz) |
| Allowable Operation Temperature | -25 °C to 70 °C |
| IP-Protection | front side IP40 acc. to IEC 60529 |
| Protection against electric shock | Suitable for appliances with protection class II acc. to IEC 61140 |
| Terminal | PCB 1.6 mm |
| Material: Housing | Thermoplastic, black, UL 94V-0 |



| | |
|-------------------------|-------------------------------------------------------------------------------------------------------------------------------------|
| Appliance inlet/-outlet | C8p following IEC 60320-1, UL 60320-1, CSA C22.2 no. 60320-1 (for cold conditions) pin-temperature 70 °C, 2.5A, Protection Class II |
| Line Switch | Rocker switch 1-pole, non-illuminated, acc. to IEC 61058-1 Technical Details |

Detailed information on product approvals, code requirements, usage instructions and detailed test conditions can be looked up in [Details about Approvals](#)

SCHURTER products are designed for use in industrial environments. They have approvals from independent testing bodies according to national and international standards. Products with specific characteristics and requirements such as required in the automotive sector according to IATF 16949, medical technology according to ISO 13485 or in the aerospace industry can be offered exclusively with customer-specific, individual agreements by SCHURTER.

Approvals

The approval mark is used by the testing authorities to certify compliance with the safety requirements placed on electronic products.
 Approval Reference Type: CMF

| Approval Logo | Certificates | Certification Body | Description |
|----------------------------------------------------------------------------------|-------------------------------|--------------------|------------------------------------------|
|  | VDE Approvals | VDE | VDE Certificate Number: 40018468 |
|  | UL Approvals | UL | UR File Number: E96454 |
|  | CCC Approvals | CCC | CCC Certificate Number: 2007010204227779 |

Product standards

Product standards that are referenced

| Organization | Design | Standard | Description |
|--------------|-----------------------|-----------------------|-----------------------------------------------------------------------|
| | Designed according to | IEC 60320-1 | Appliance couplers for household and similar general purposes |
| | Designed according to | IEC 61058-1 | Switches for appliances. Part 1. General requirements |
| | Designed according to | UL 60320-1 | Standard for Attachment Plugs and Receptacles |
| | Designed according to | CSA C22.2 no. 60320-1 | General Use Receptacles, Attachment Plugs, and Similar Wiring Devices |





Application standards

Application standards where the product can be used

| Organization | Design | Standard | Description |
|--------------|--------------------------------|----------------|-----------------------------------------------------------------------------------------------|
| | Suitable for applications acc. | IEC/UL 62368-1 | Audio/video, information and communication technology equipment - Part 1: Safety requirements |

Compliances

The product complies with following Guide Lines

| Identification | Details | Initiator | Description |
|------------------------------------------------------------------------------------|------------------------------------------------|-------------|-------------------------------------------------------------------------------------------------------------------------------------------------------------------------------------------------------|
|  | CE declaration of conformity | SCHURTER AG | The CE marking declares that the product complies with the applicable requirements laid down in the harmonisation of Community legislation on its affixing in accordance with EU Regulation 765/2008. |
|  | UKCA declaration of conformity | SCHURTER AG | The UKCA marking declares that the product complies with the applicable requirements laid down in the British Amendment of Regulation (EC) 765/2008. |
|  | RoHS | SCHURTER AG | Directive RoHS 2011/65/EU, Amendment (EU) 2015/863 |
|  | China RoHS | SCHURTER AG | The law SJ / T 11363-2006 (China RoHS) has been in force since 1 March 2007. It is similar to the EU directive RoHS. |

Dimensions [mm]

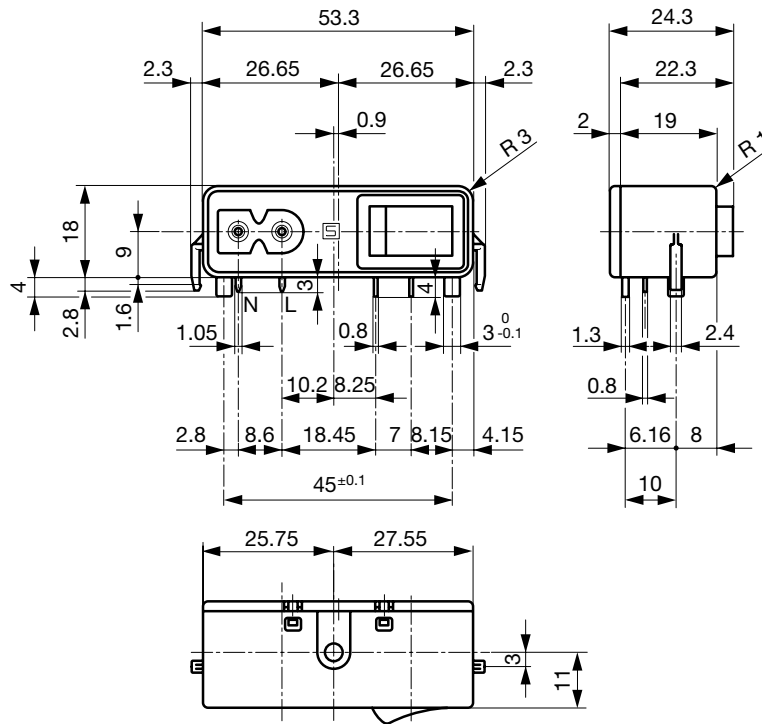

With insulation cover
 The size of the mounting cut-out can be selected as required.

Drilling Diagram / CMF1 and CMF2

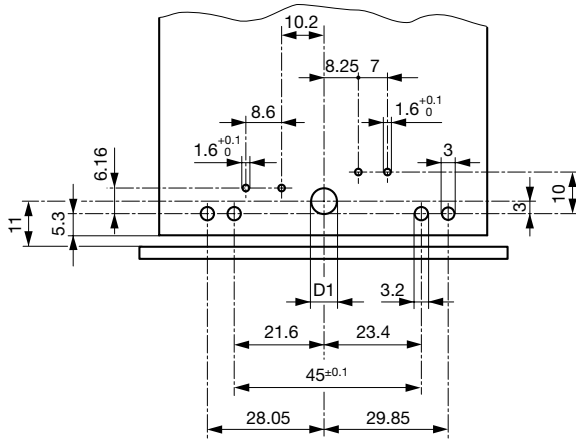

D1 = 6.2 mm mounting from above
 D1 = 3.6 mm mounting from below

Fixation on PCB or housing from below

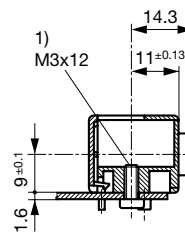

1) self tapping screw

Fixation on PCB or housing from above

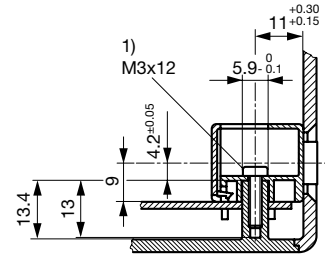

1) self tapping screw

All Variants

| Connectors | Mounting side | Cover | Ground terminal | Ground terminal direction | Order Number |
|------------|---------------|---------------|-----------------|---------------------------|--------------|
| C8p | from below | with cover | - | - | CMF2.1131.12 |
| C8p | from below | without cover | - | - | CMF2.1031.12 |
| C8p | from top | with cover | - | - | CMF2.1111.12 |
| C8p | from top | without cover | - | - | CMF2.1011.12 |

Availability for all products can be searched real-time: <https://www.schurter.com/en/info-center/support-tools/stock-check-distributors>

Packaging unit

50 Pcs