

IEC Appliance Inlet C6 with Line Switch 1-pole



CMF3  
 IEC connector C6 with line switch 1-pole  
 PCB Mounting



See below:  
[Approvals and Compliances](#)

**Description**

- Panel mount :  
 Screw-on mounting on PCB , from top or bottom
- 2 Functions :  
 Appliance Inlet Protection class I , Line Switch 1-pole
- For PCB mounting

**Characteristics**

- Easy mounting with center bolt and snapper or screwed on PCB or housing
- Electrical connection done on the PCB
- Bi-positioning of the switch from left or right side, Standard CMF with switch on right side
- With or without rear-side insulation cover
- Suitable for use in equipment according to IEC/UL 60950

**Other versions on request**

- Line switch with other rocker marking
- Line switch on left of inlet

**References**

Alternative: protection class II version [CMF1](#), [CMF4](#); [CMF2](#), [CMF5](#)

**Weblinks**

[pdf data sheet](#), [html datasheet](#), [General Product Information](#), [Distributor-Stock-Check](#), [Accessories](#), [Detailed request for product](#)

**Technical Data**

Ratings IEC	2.5 A / 250 VAC; 50 Hz	appliance inlet/-outlet	C6 acc. to IEC 60320-1, UL 60320-1, CSA C22.2 no. 60320-1 (for cold conditions) pin-temperature 70 °C, 2.5 A, Protection Class I
Ratings UL/CSA	2.5 A / 250 VAC; 60 Hz 7 A / 125 VAC; 60 Hz	Line Switch	Rocker switch 1-pole, non-illuminated, acc. to IEC 61058-1 <a href="#">Technical Details</a>
Dielectric Strength	> 2.3 kVAC between L-N > 2.8 kVAC between L/N-PE (1 min/50 Hz)		
Allowable Operation Temperature	-25 °C to 70 °C		
IP-Protection	from front side IP40 acc. to IEC 60529		
Protection against electric shock	Suitable for appliances with protection class I acc. to IEC 61140		
Terminal	PCB 1.6 mm Additional ground terminal		
Material: Housing	Thermoplastic, black, UL 94V-0		



**Approvals and Compliances**

Detailed information on product approvals, code requirements, usage instructions and detailed test conditions can be looked up in [Details about Approvals](#)

SCHURTER products are designed for use in industrial environments. They have approvals from independent testing bodies according to national and international standards. Products with specific characteristics and requirements such as required in the automotive sector according to IATF 16949, medical technology according to ISO 13485 or in the aerospace industry can be offered exclusively with customer-specific, individual agreements by SCHURTER.





## Approvals

The approval mark is used by the testing authorities to certify compliance with the safety requirements placed on electronic products.  
 Approval Reference Type: CMF

Approval Logo	Certificates	Certification Body	Description
	<a href="#">VDE Approvals</a>	VDE	VDE Certificate Number: 40018468
	<a href="#">UL Approvals</a>	UL	UL File Number: E96454
	<a href="#">CCC Approvals</a>	CCC	CCC Certificate Number: 2007010204227779

## Product standards

Product standards that are referenced

Organization	Design	Standard	Description
	Designed according to	IEC 60320-1	Appliance couplers for household and similar general purposes
	Designed according to	IEC 61058-1	Switches for appliances. Part 1. General requirements
	Designed according to	UL 60320-1	Standard for Attachment Plugs and Receptacles
	Designed according to	CSA C22.2 no. 60320-1	General Use Receptacles, Attachment Plugs, and Similar Wiring Devices





## Application standards

Application standards where the product can be used

Organization	Design	Standard	Description
	Designed for applications acc.	IEC/UL 60950	IEC 60950-1 includes the basic requirements for the safety of information technology equipment.

## Compliances

The product complies with following Guide Lines

Identification	Details	Initiator	Description
	<a href="#">CE declaration of conformity</a>	SCHURTER AG	The CE marking declares that the product complies with the applicable requirements laid down in the harmonisation of Community legislation on its affixing in accordance with EU Regulation 765/2008.
	<a href="#">RoHS</a>	SCHURTER AG	Directive RoHS 2011/65/EU, Amendment (EU) 2015/863
	<a href="#">China RoHS</a>	SCHURTER AG	The law SJ / T 11363-2006 (China RoHS) has been in force since 1 March 2007. It is similar to the EU directive RoHS.
	<a href="#">REACH</a>	SCHURTER AG	On 1 June 2007, Regulation (EC) No 1907/2006 on the Registration, Evaluation, Authorization and Restriction of Chemicals 1 (abbreviated as "REACH") entered into force.

Dimensions [mm]

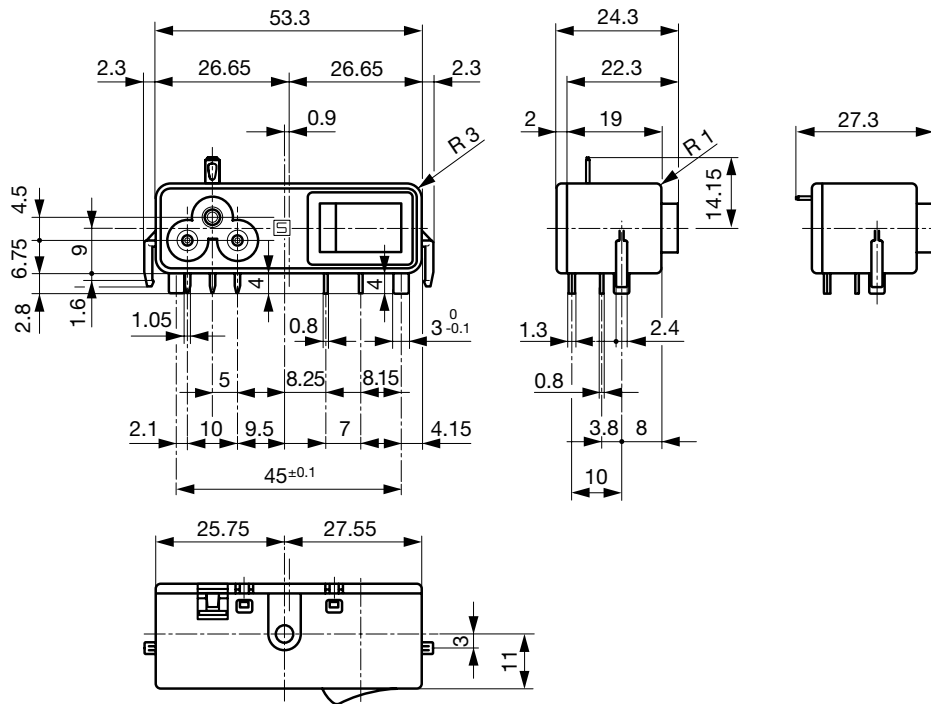

With insulation cover  
 The size of the mounting cut-out can be selected as required.  
 Drilling Diagram / CMF3 (C6)

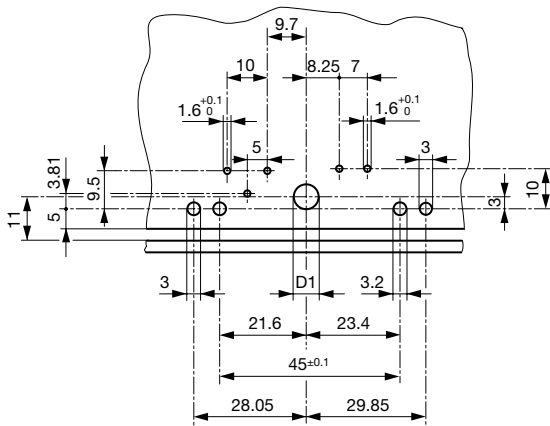

D1 = 6.2 mm mounting from above / D1 = 3.6 mm mounting from below  
 PC Board 1.6 mm / Dimensions without tolerance:  $\leq 15 = \pm 0.05$  /  $> 15 = \pm 0.10$   
 Drilling diagram CMF6 mirror-inverted

Fixation on PCB or housing from below

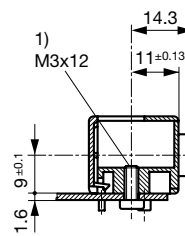

1) self tapping screw

Fixation on PCB or housing from above

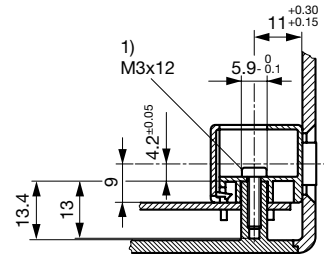

1) self tapping screw

All Variants

Connectors	Mounting side	Cover	Ground terminal	Ground terminal direction	Order Number
C6	from below	with cover	-	-	CMF3.1132.12
C6	from below	with cover	Solder terminal 2.8 x 0.8 mm	angled to pin axis	CMF3.1133.12
C6	from below	with cover	Solder terminal 2.8 x 0.8 mm	straight	CMF3.1134.12
C6	from below	without cover	-	-	CMF3.1032.12
C6	from below	without cover	Solder terminal 2.8 x 0.8 mm	angled to pin axis	CMF3.1033.12
C6	from below	without cover	Solder terminal 2.8 x 0.8 mm	straight	CMF3.1034.12
C6	from top	with cover	-	-	CMF3.1112.12
C6	from top	with cover	Solder terminal 2.8 x 0.8 mm	angled to pin axis	CMF3.1113.12
C6	from top	with cover	Solder terminal 2.8 x 0.8 mm	straight	CMF3.1114.12

Connectors	Mounting side	Cover	Ground terminal	Ground terminal direction	Order Number
C6	from top	without cover	-	-	<a href="#">CMF3.1012.12</a>
C6	from top	without cover	Solder terminal 2.8 x 0.8 mm	angled to pin axis	<a href="#">CMF3.1013.12</a>
C6	from top	without cover	Solder terminal 2.8 x 0.8 mm	straight	<a href="#">CMF3.1014.12</a>

Availability for all products can be searched real-time: <https://www.schurter.com/en/Stock-Check/Stock-Check-SCHURTER>

**Packaging unit**      50 Pcs